

Troubleshooting Guide

Problem	Reason	Solution
Unit does not turn on.	<ol style="list-style-type: none"> 1. Power Cord 2. Switch 3. AHPCO™ Cell 	<ol style="list-style-type: none"> 1. Check to make sure power cord is plugged in. 2. Check to make sure switch is in the on position. 3. Check to make sure UV lamp within AH-PCO™ Cell is plugged in completely.
Unit is not reducing odors.	<ol style="list-style-type: none"> 1. Defective AHPCO™ Cell 	<ol style="list-style-type: none"> 1. Check to make sure the AHPCO™ Cell has a blue glow. If you see no glow or the glow has turned to a purple color, contact Air Oasis.



Owner's Manual

This Manual Includes:

- Warranty
- Safety Warnings
- Operating Instructions
- Replacement Directions
- Troubleshooting Tips
- Cleaning and Maintenance Tips



Before operating this unit carefully read the contents of this manual.

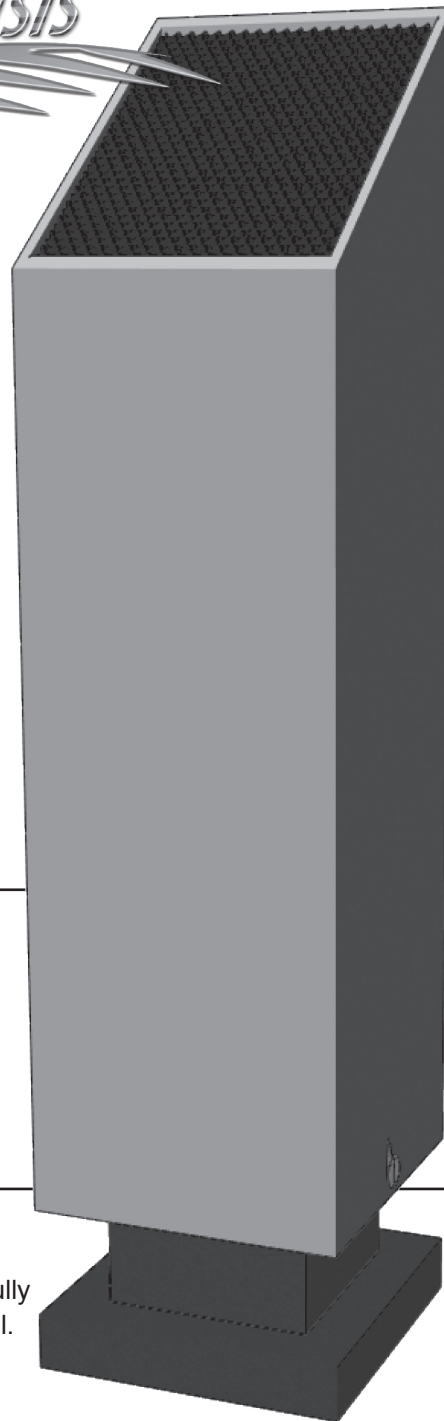

3401 Airway Blvd.
Amarillo, TX 79118

Toll-Free: 1-800-936-1764 Fax: 1-806-373-7799
www.AirOasis.com

Important Safety Instructions

When operating electrical appliances, basic precautions should always be followed.

WARNING To reduce the risk of fire, electric shock or injury:

- Do not use outdoors or on wet surfaces.
- Use only as described in this manual.
- Do not use with damaged cord or plug. If appliance is not working as it should, has been dropped, damaged, left outdoors, or dropped into water, call customer service at 1-800-936-1764.
- Do not unplug by pulling on cord. To unplug, grasp the plug, not the cord.
- Do not handle plug or appliance with wet hands.
- Do not put any object into openings.
- Turn off all controls before unplugging.



CAUTION



AHPCO™ Cell contains Hg (Mercury) and should be disposed of according to disposal laws. Find disposal centers at www.earth911.org.

If the UV lamp is broken do not touch the cell or glass with your hands.

UV lamp may be hot and could cause serious burns if not handled properly. Please wait until the AHPCO Cell has cooled to room temperature to remove from unit.

WARNING: UV Light Hazard. Harmful to skin and eyes. Can cause temporary or permanent loss of vision. Never look at the lamp while illuminated. To prevent exposure to ultraviolet light, be sure the power is disconnected before servicing.

WARNING: RISK OF ELECTRICAL SHOCK. CAN CAUSE INJURY OR DEATH: DISCONNECT ALL POWER SUPPLIES BEFORE ANY SERVICING.

Step 3

3. Replace with new cell.

Be sure the UV lamp is completely plugged in.

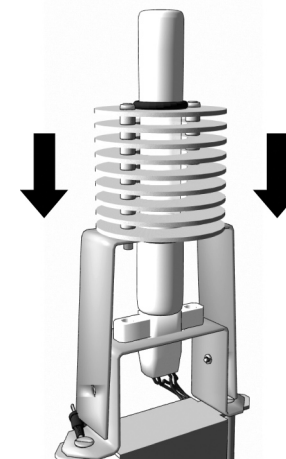

Step 4

4. Slide shell down onto base and replace screws. (Cord and switch are to the back.)

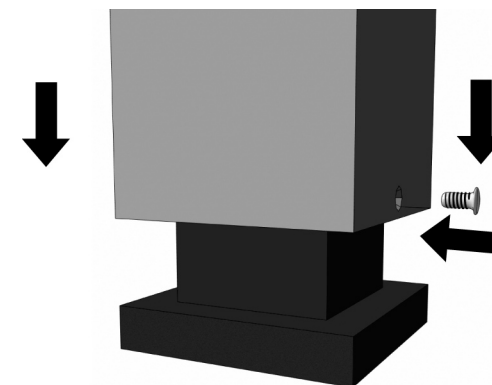

Replacement Date Reminder

The AHPCO™ Cell should be replaced every three years.

3 Years Date: _____

6 Years Date: _____

9 Years Date: _____

Hg lamp contains mercury. Manage in accord with disposal laws. Find disposal centers at www.earth911.org.

AHPCO™ Cell Replacement

Step 1

 **CAUTION:** Before attempting to service the Air Oasis unit, be sure the power is off and unplugged.

 **DANGER - NEVER LOOK DIRECTLY AT ILLUMINATED AHPCO CELL**

1. Remove two (2) screws at the bottom sides holding outer shell in place. Then slide the shell up and off of the internal base.

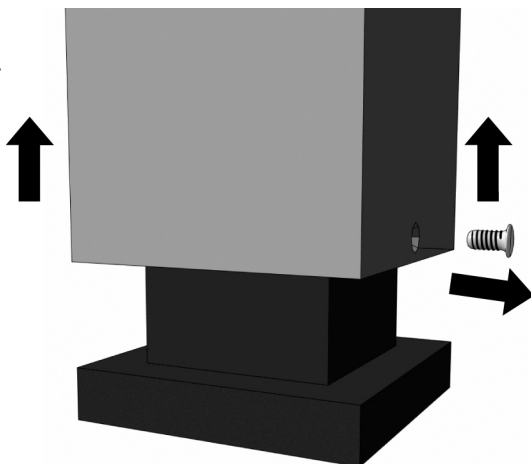

Step 2

2. Grasp the metal clips of the AHPCO Cell and pull outward and upward to release from bracket.

 **CAUTION** 

UV lamp may be hot and could cause serious burns if not handled properly. Please wait until AHPCO Cell has cooled to room temperature to remove from unit.

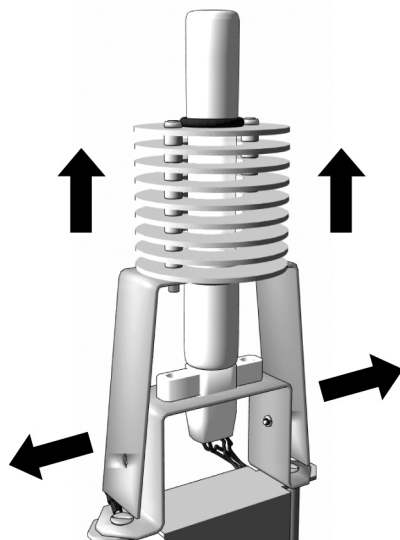

 **Read all instructions carefully before operating your air purifier.**

Table of Contents

Safety Instructions and Cautions	1
Table of Contents	2
Warranty	3
Maintenance and Customer Service	4
Placement and Operation	4
Cleaning	4
AHPCO™ Cell Replacement	5-6
Troubleshooting Guide	7

Warranty

Air Oasis gives you the following limited warranty for this product only if it was originally purchased directly from Air Oasis or an Air Oasis Authorized Retail Dealer.

Air Oasis will repair or replace, free of charge, to the original purchaser, any part that is found to be defective in material or workmanship within three (3) years of the date of purchase.

This limited warranty covers the replacement of expendable or consumable parts such as the AHPCO Cell.

This limited warranty does not apply to any part subjected to accident, abuse, industrial use, alteration, misuse, damage caused by act of God, the use of voltages other than indicated on the label displayed on this product or service of this product by anyone other than Air Oasis.

Air Oasis does not authorize any person or representative to assume or grant any other warranty obligation with the sale of this product.

Air Oasis' limited warranty is valid only if you retain proof of purchase from Air Oasis or an Air Oasis Authorized Retail Dealer for this product. If you purchase this product from any other source, your purchase is "AS IS", which means Air Oasis grants you no warranty, and that you, not Air Oasis, assume the entire risk of the quality and performance of this product, including the entire cost of any necessary servicing or repairs of any defects.

Air Oasis' liability for damages to you for any costs whatsoever arising out of this statement of limited warranty shall be limited to the amount paid for this product at the time of original purchase, and Air Oasis shall not be liable for any direct, indirect, consequential or incidental damages arising out of the use or inability to use this product.

ALL EXPRESS AND IMPLIED WARRANTIES FOR THIS PRODUCT, INCLUDING IMPLIED WARRANTIES OF MERCHANTABILITY AND FITNESS FOR A PARTICULAR PURPOSE, ARE LIMITED IN DURATION TO THE WARRANTY PERIOD, AND NO WARRANTIES, WHETHER EXPRESS OR IMPLIED, WILL APPLY AFTER THIS PERIOD.

Some states do not allow limitations on the duration of implied warranties, so the above limitation may not apply to you. This warranty gives you specific legal rights, and you may also have other rights which vary from state to state.

To obtain warranty service and return authorization number, contact us at:
PH: (800) 936-1764, FAX: (806) 373-7799 or E-mail to feedback@airoasis.com

NOTE: All returned packages that do not have an RMA# will be refused.

Maintenance and Customer Service

If you require any additional information or have problems with your Air Oasis appliance, you may call Air Oasis customer service at:

1-800-936-1764

Please have your serial and model numbers, found on bottom of unit, handy when calling.

Save your sales receipt to show if your Air Oasis appliance should ever need any warranty service.

Placement and Operation

For best results the unit should be placed in a central location and three feet or higher from the ground.

Operation is very simple. Remove the Air Oasis from the packaging. Place in desired location, plug it in and rock the switch to the high or low position. The unit can remain in the on position 24/7.

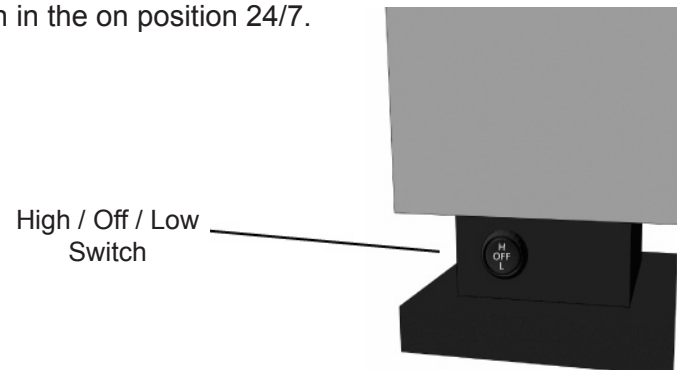

Optional Cleaning



Make sure that the power cord is unplugged prior to cleaning.

Honeycomb - Use soft pipe cleaners or compressed air to remove any dust build-up from the honeycomb vent located at the top of the unit.

Aluminum Shell - We recommend using stainless steel/aluminum spray on polish or multi-surface cleaners. Make sure the polish or cleaner is recommended for use on aluminum.

Internal - Take dry cloth and wipe inside the shell and around the aluminum brackets and the ballast or spray with compressed air.

NOTE: Use compressed air only to clean AHPCO Cell. Any removal of catalyst coating will decrease the effectiveness of your unit and void the warranty.